

A	B	C (mm)	D
1	S220-0001	2100	526
2	S220-1001	2048	540
3	S220-1002	2048	540
4	S220-1006	1729	510
5	S220-1007	2048	520
6	S220-2005	2225	540
7	S220-2006	2225	540
8	S220-3002	1088	520
9	S220-3003	558	505
10	S220-3004	1088	520
11	S220-5502	400	179
12	S220-7001	2100	596
13	S220-7004	100	336
14	S220-9303	2058	1101
15	dr-1085	1085	30
16	dr-506	506	22

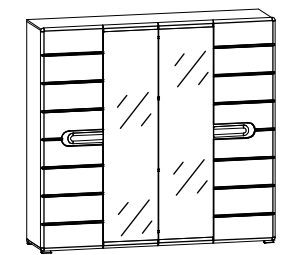

8x K16 a43	8x K9,5 a68	16x D3 b35	12x Ø5x17 mm d1	12x Ø7x50 mm e1	20x Ø8x30 mm f1	2x Ø8x50 mm f6	3x k53	4x 84x40/25 mm k77	37x l1	32x l2	4x h=22mm n1	14x 20x13x3,5/1 n108
16x Ø5,3/Ø8,3x4,8 mm o54	4x Ø3,5x13 mm p1	11x Ø4x25 mm p36	16x Ø3,5x16 mm p38	32x Ø3,5x15 mm p51	14x Ø2,9x16 mm p55	12x Ø15x12 mm #16 r1	12x Ø15x15 mm #22 r3	3x 36/20 mm r28	18x r42	24x Ø16 s2	1x z1	
											2x n26/1	2x Ø3,5x16 mm p38

1

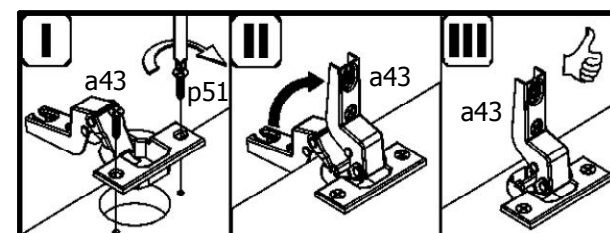
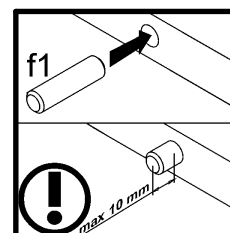
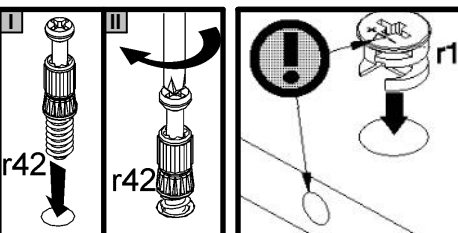
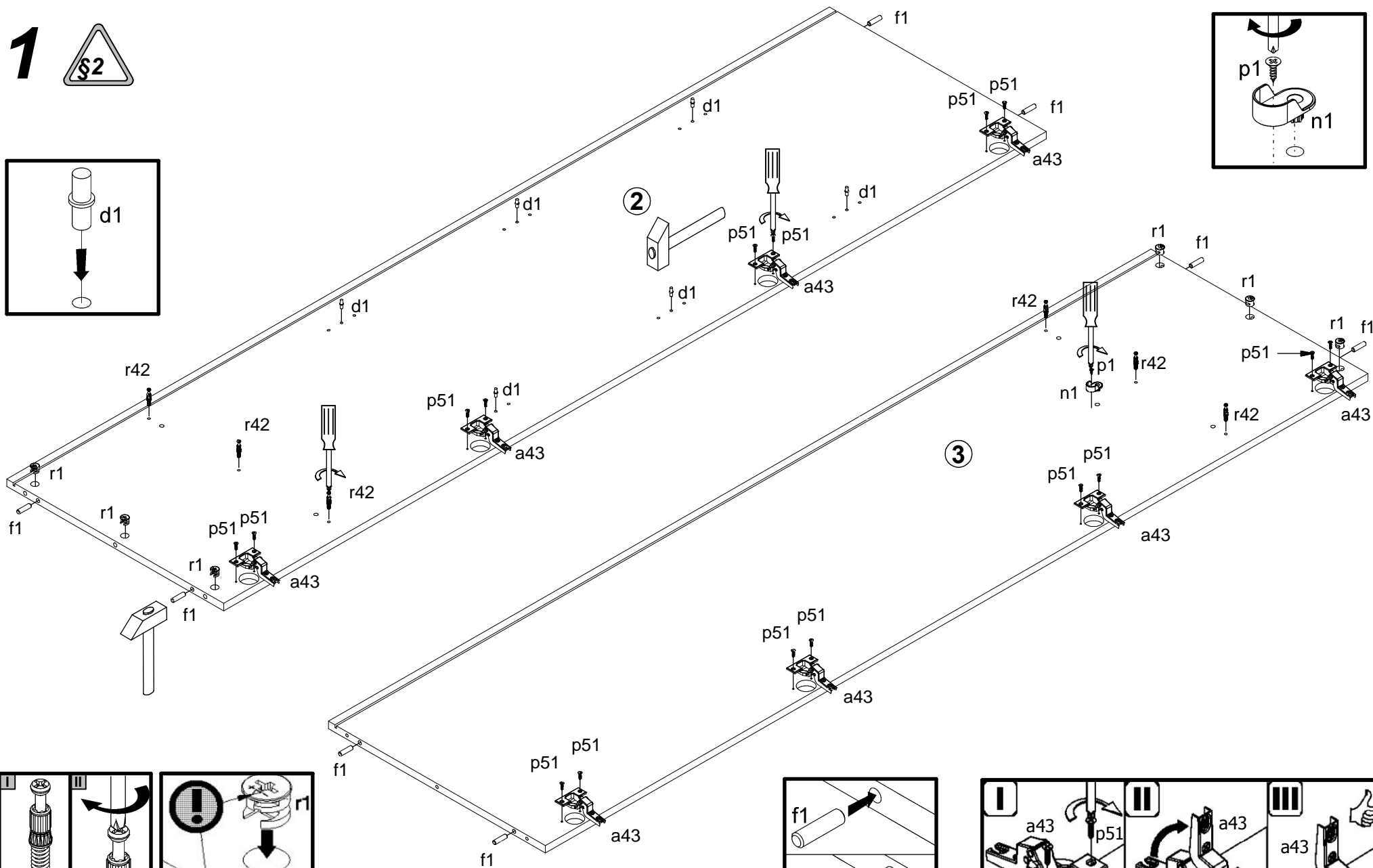
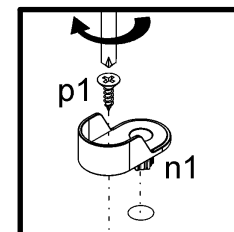
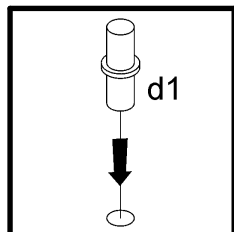

1 

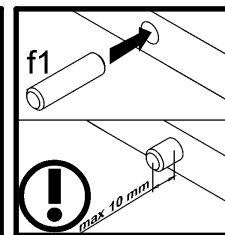
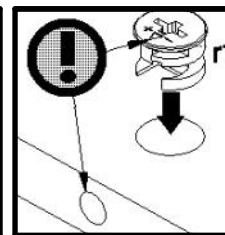
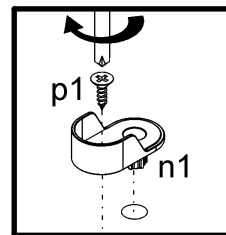
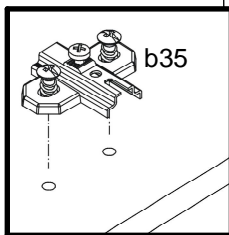
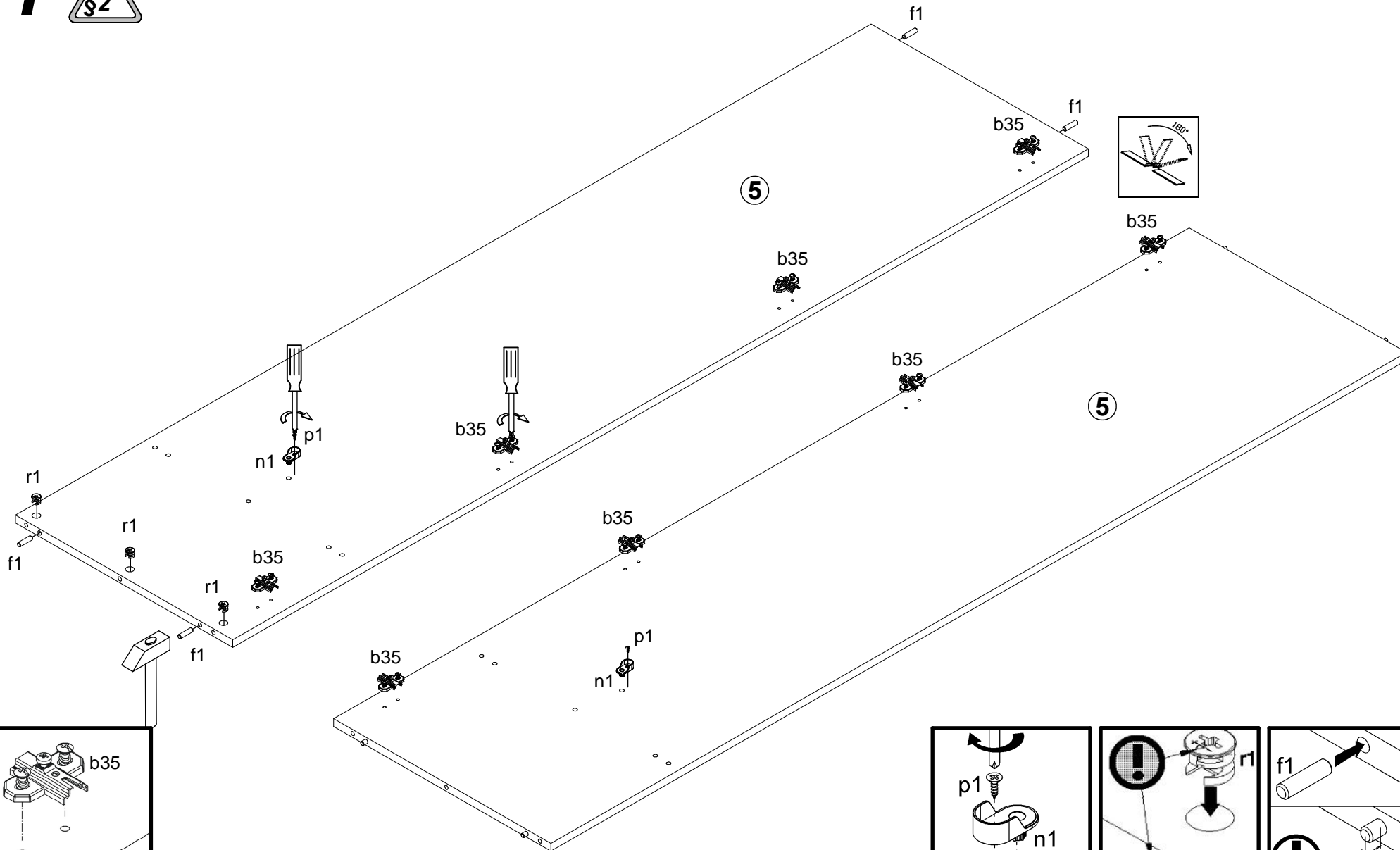

1

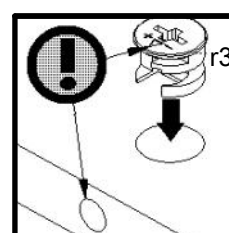
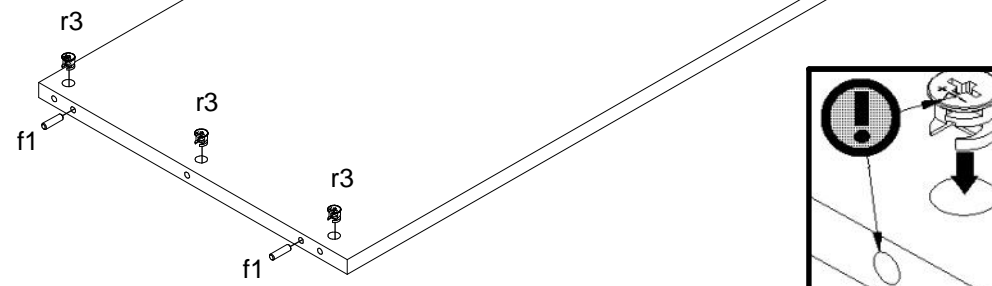
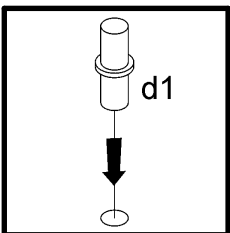
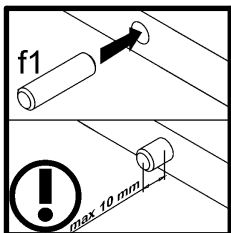
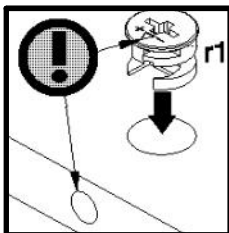
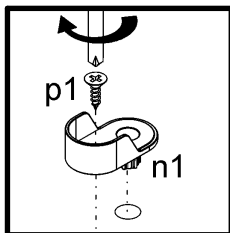
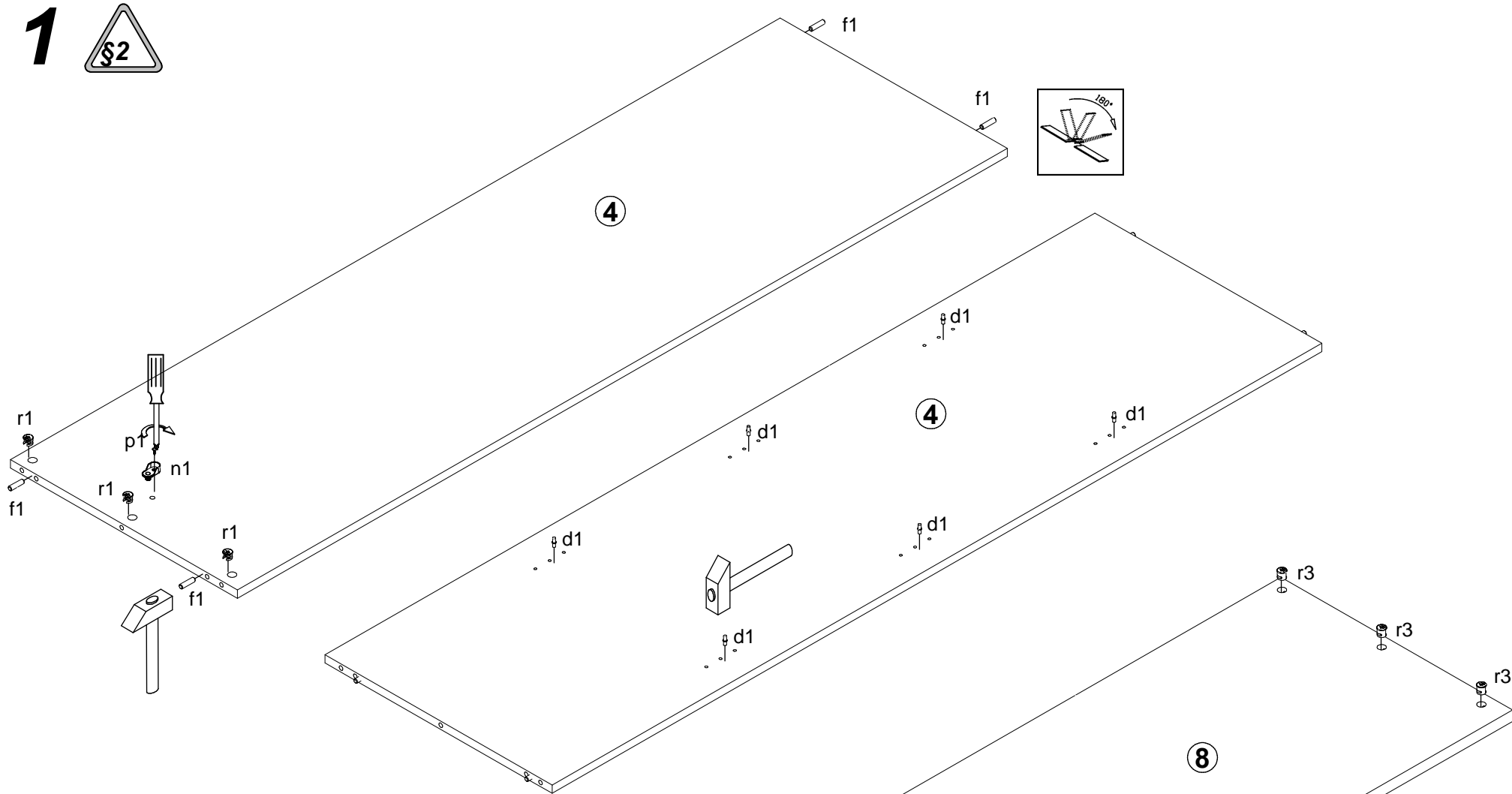

1

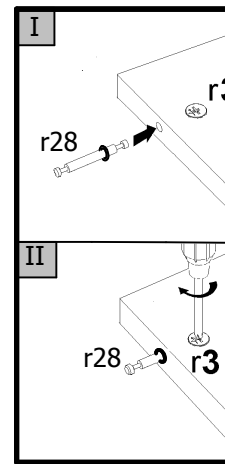
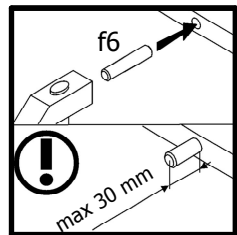
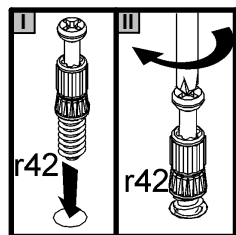
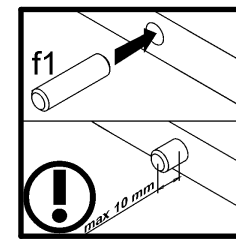
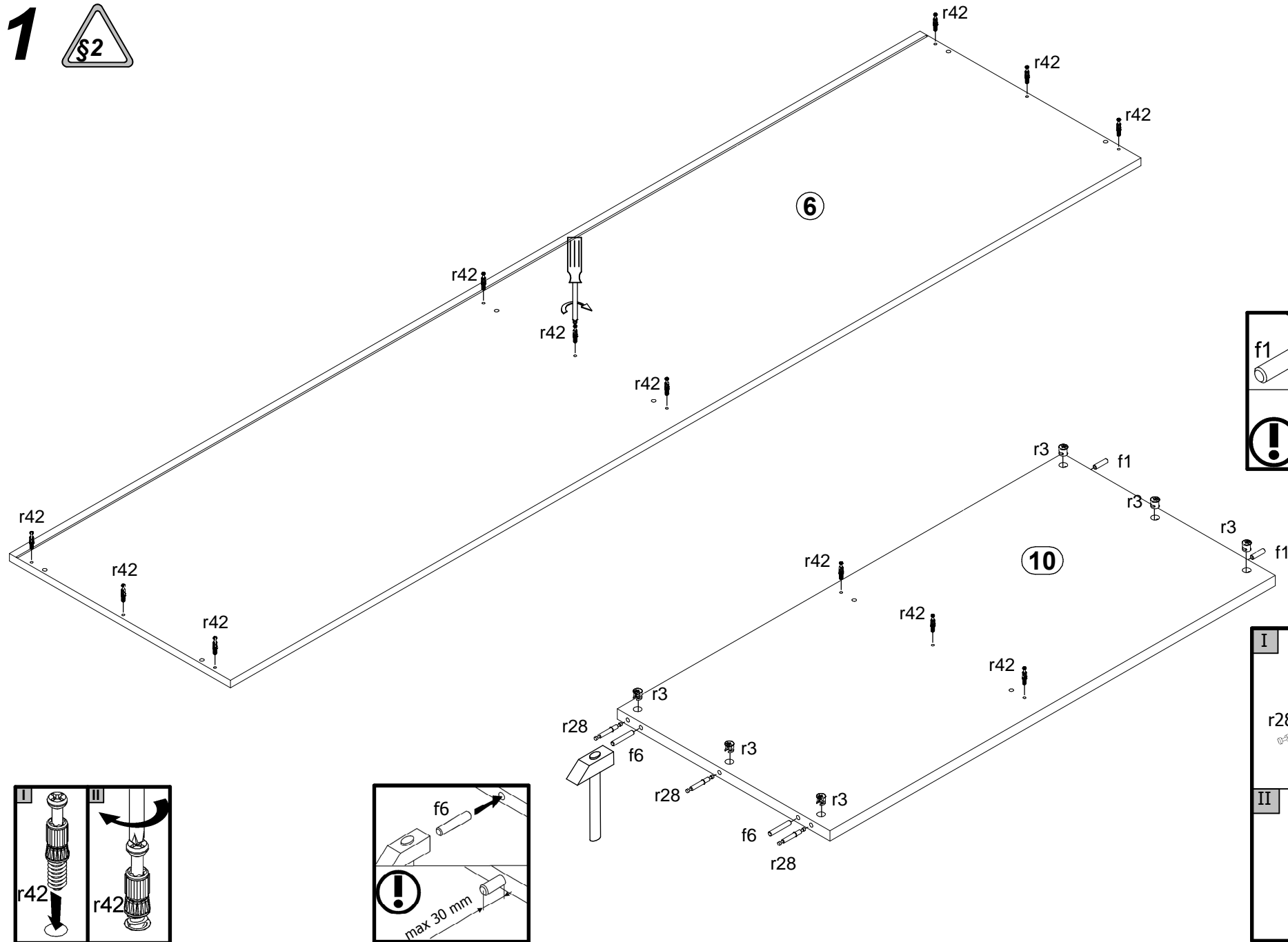

1

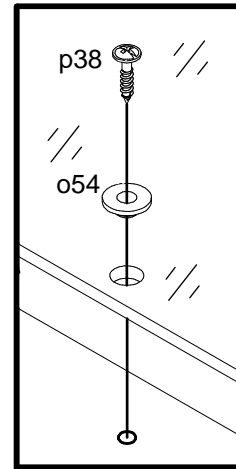
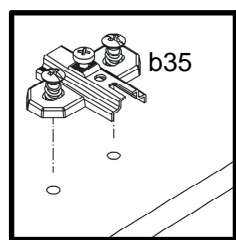
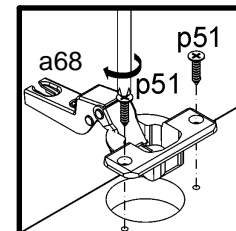
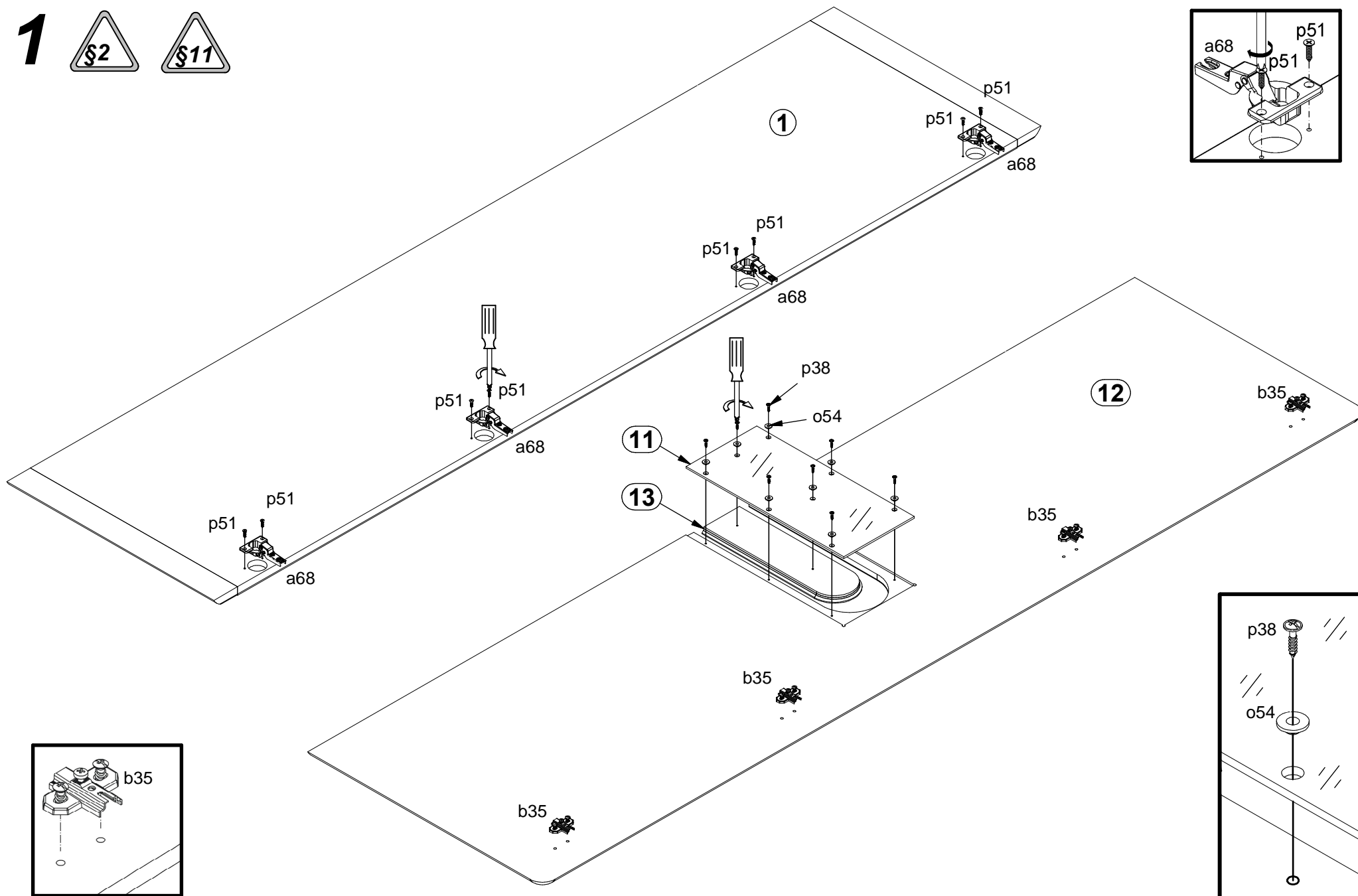

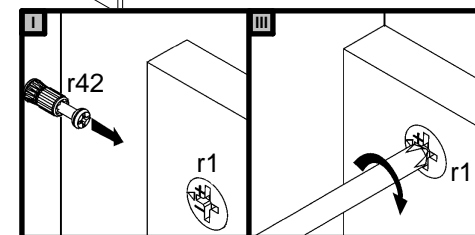
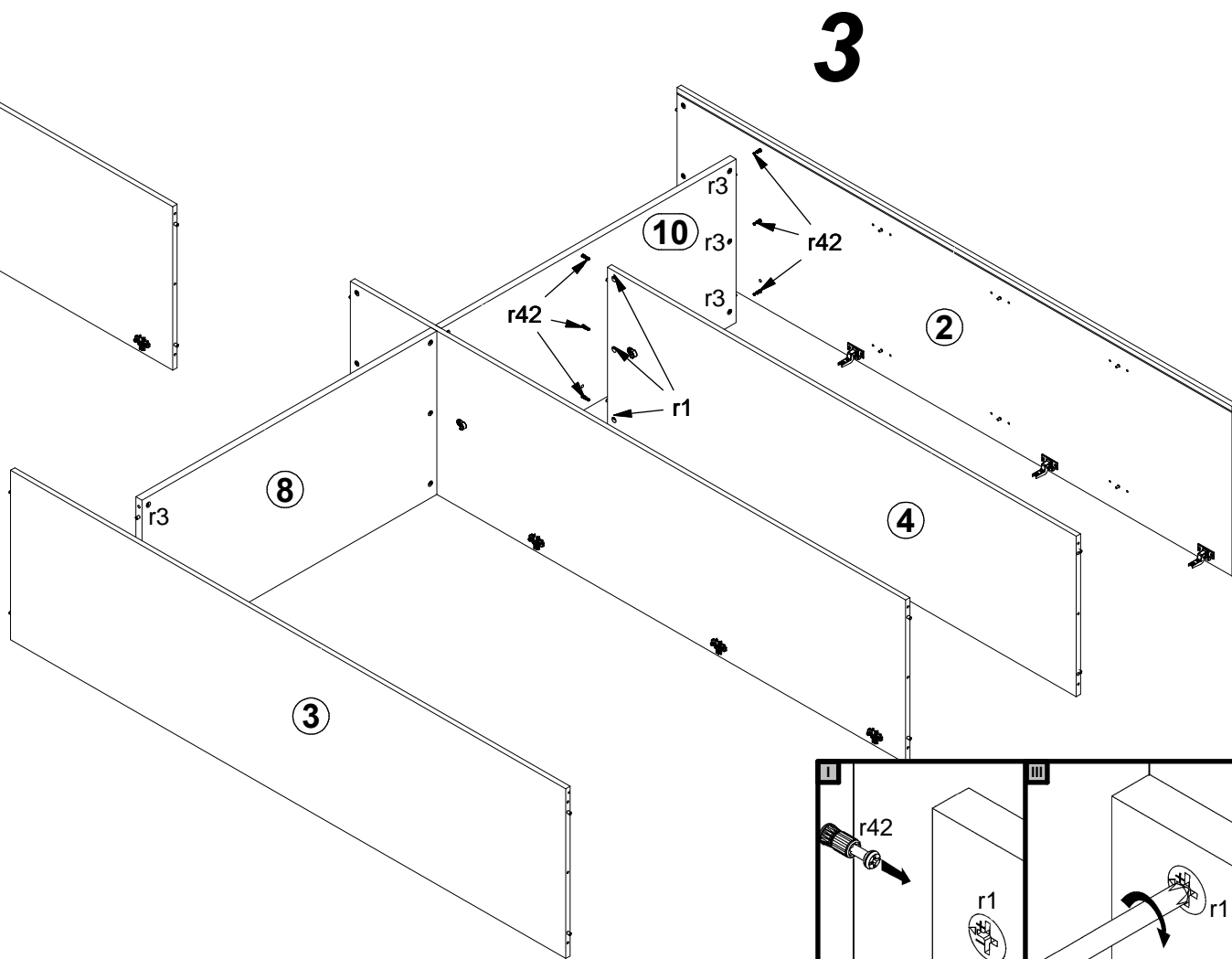
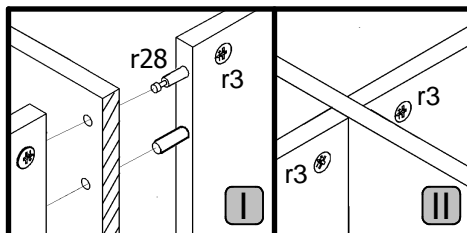
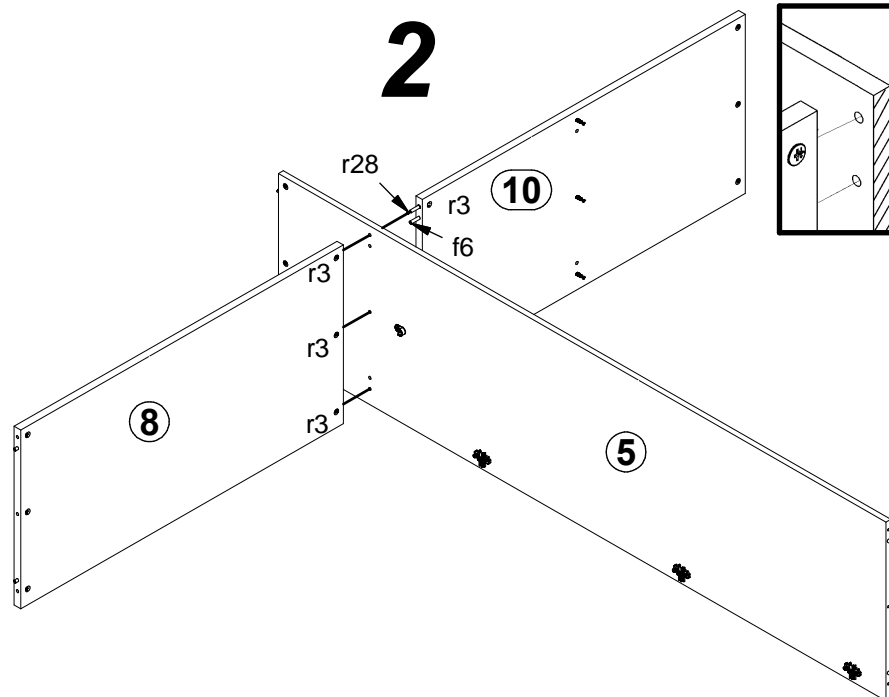



4

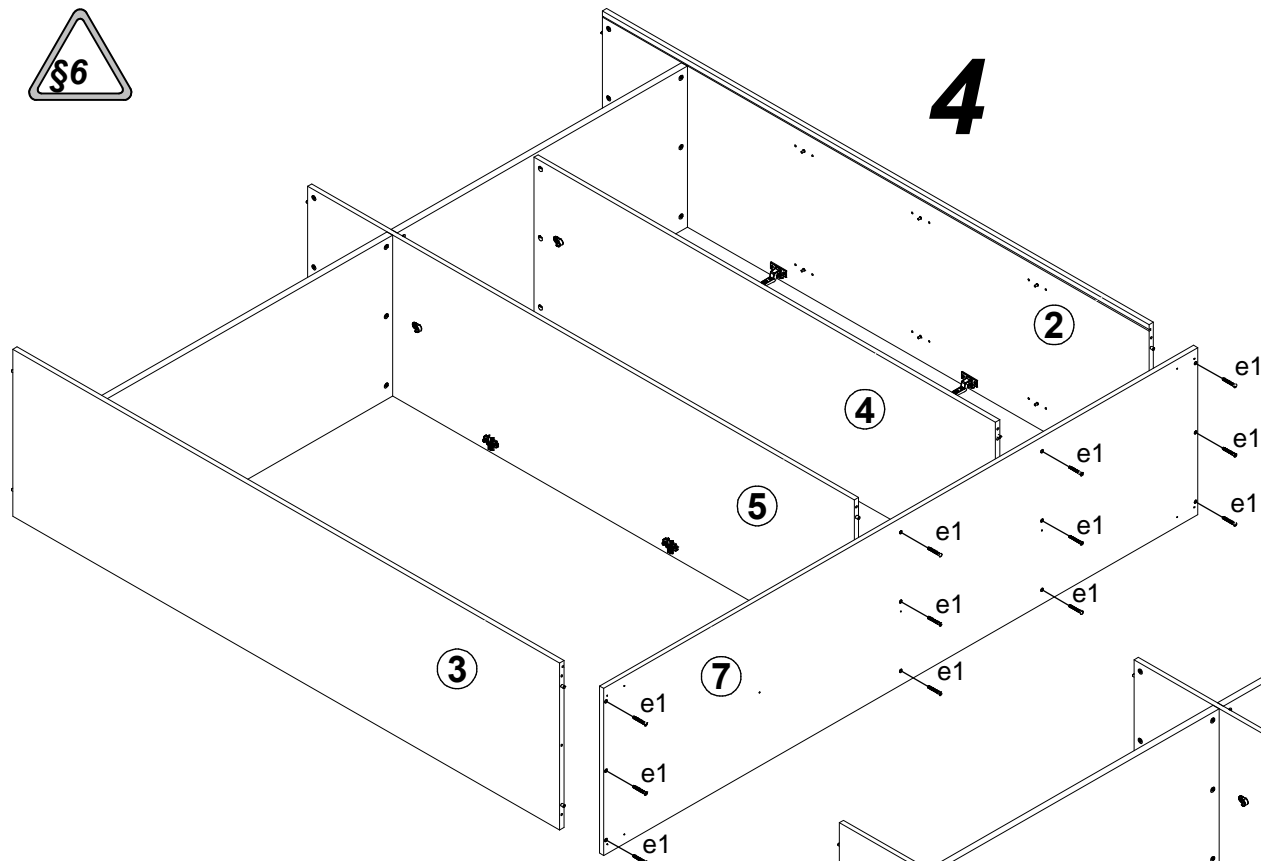
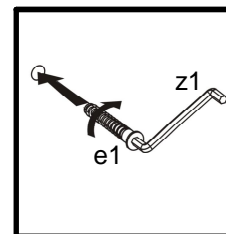

5

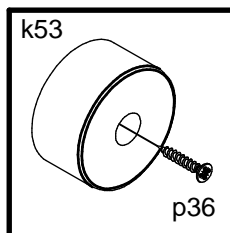
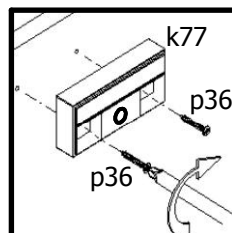
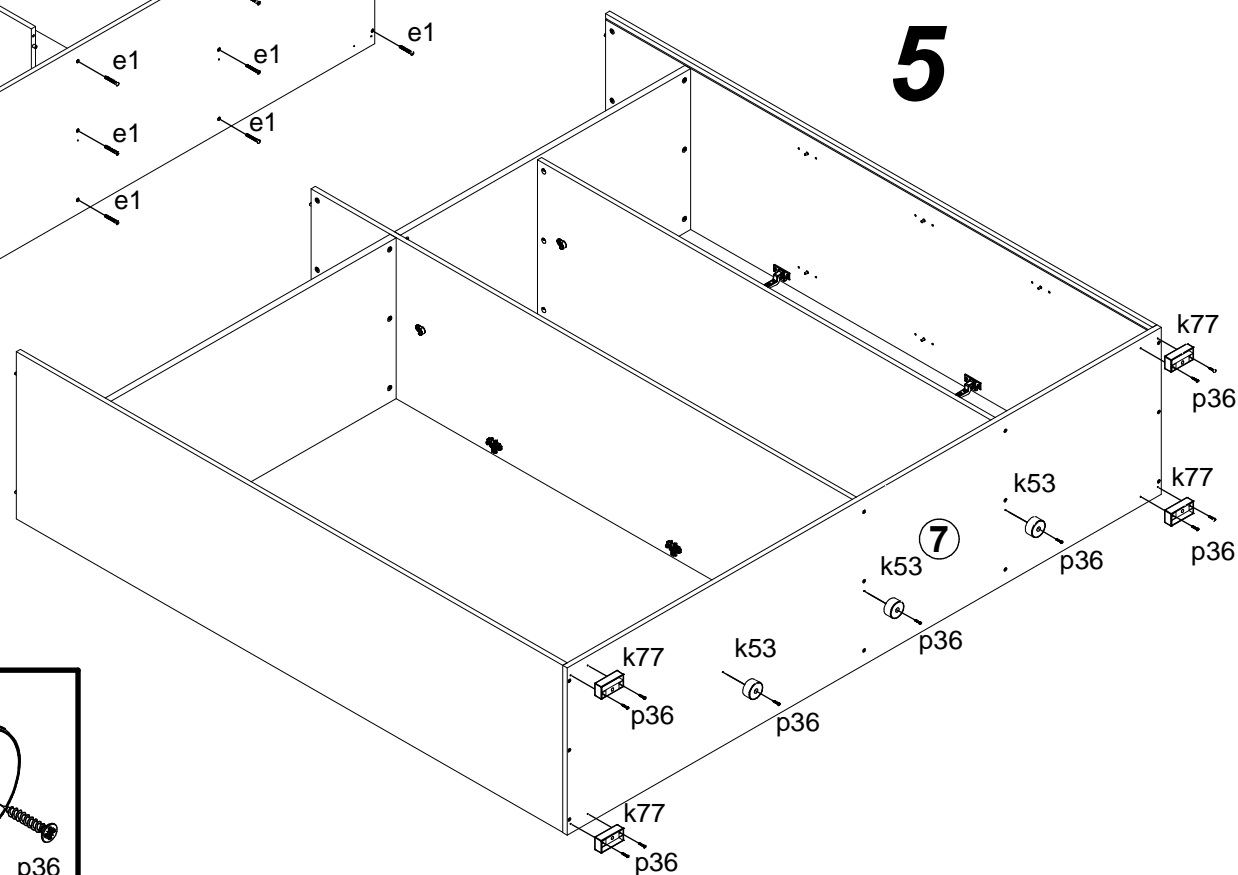

6

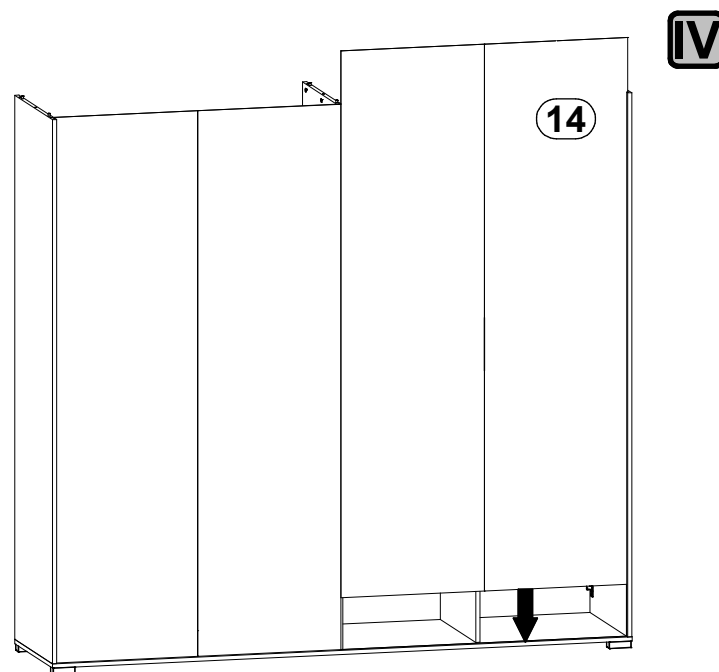
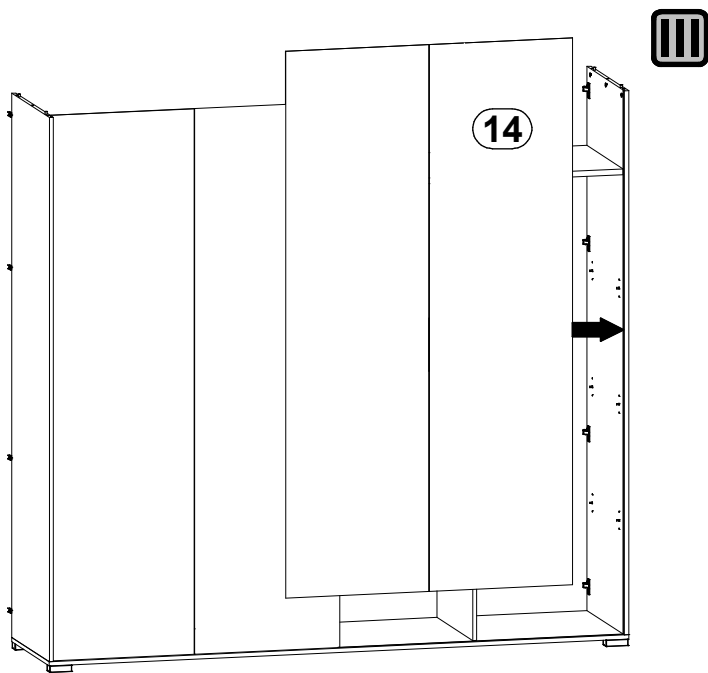
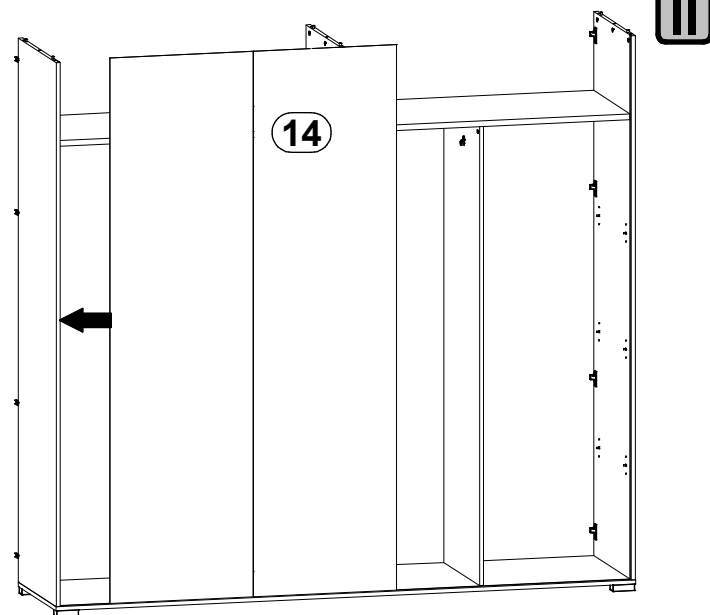
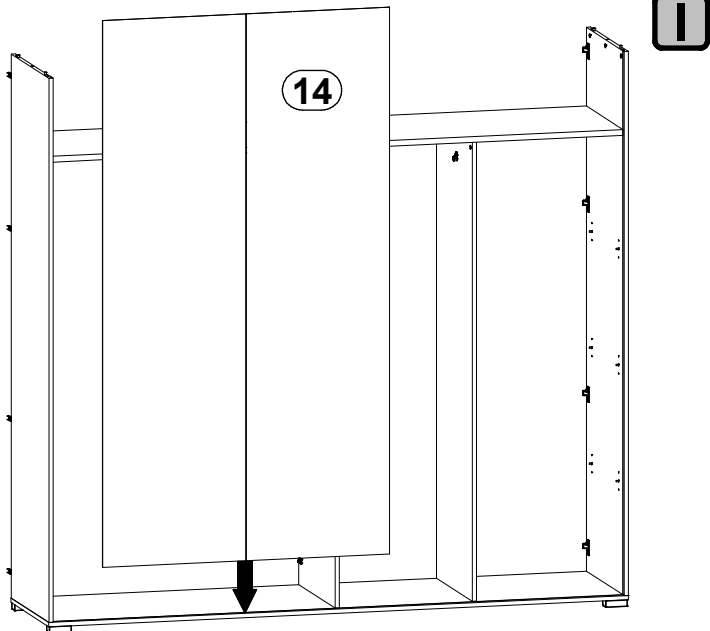



7

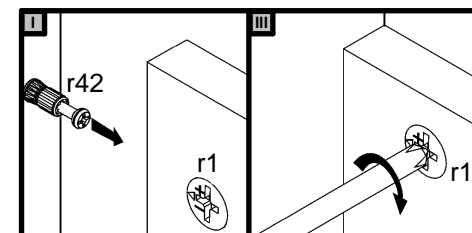
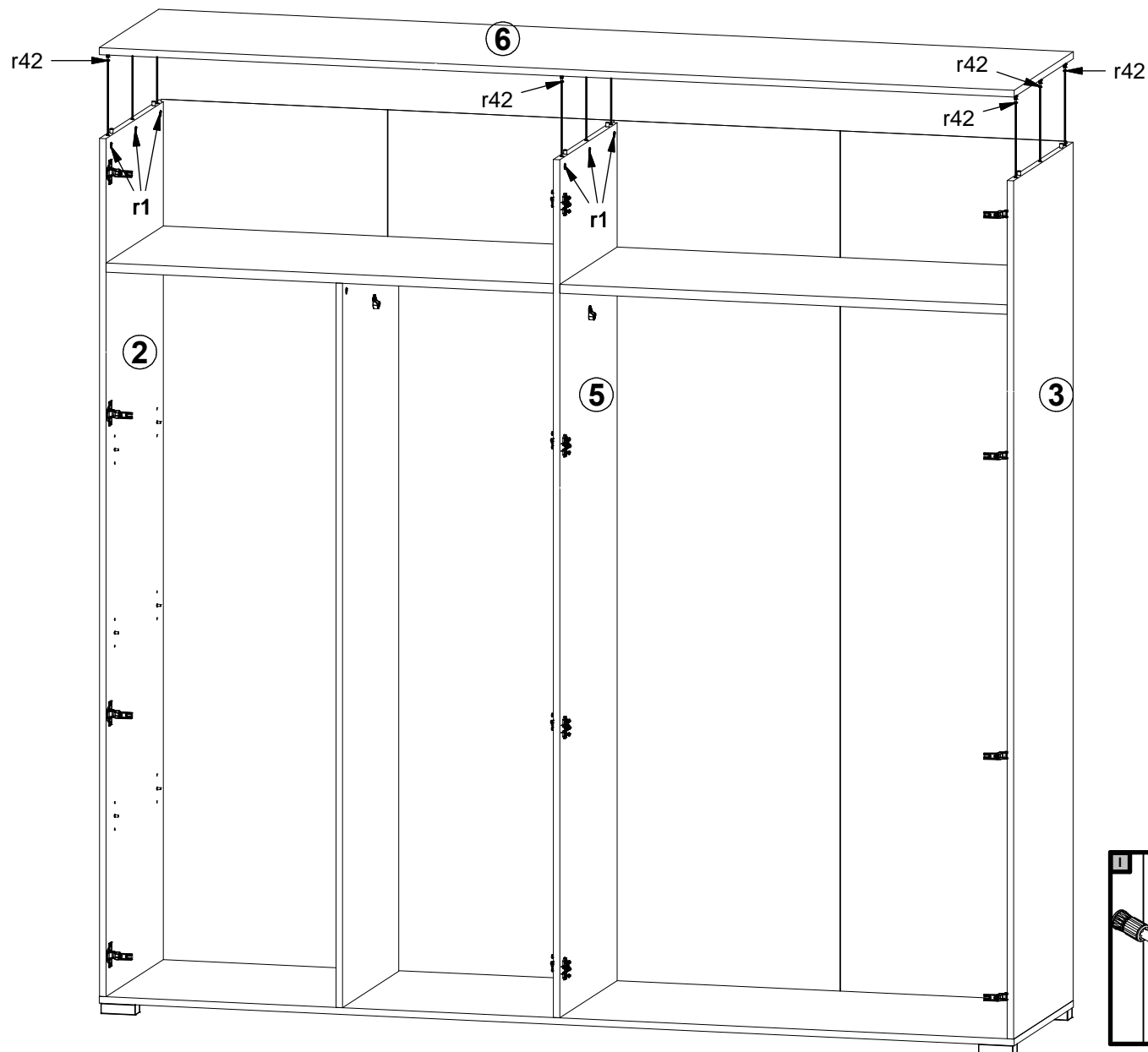

8

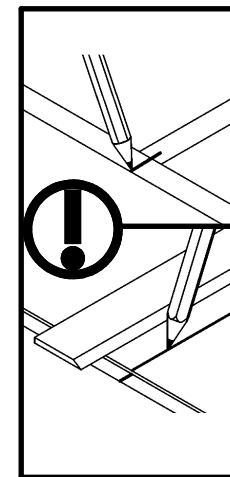
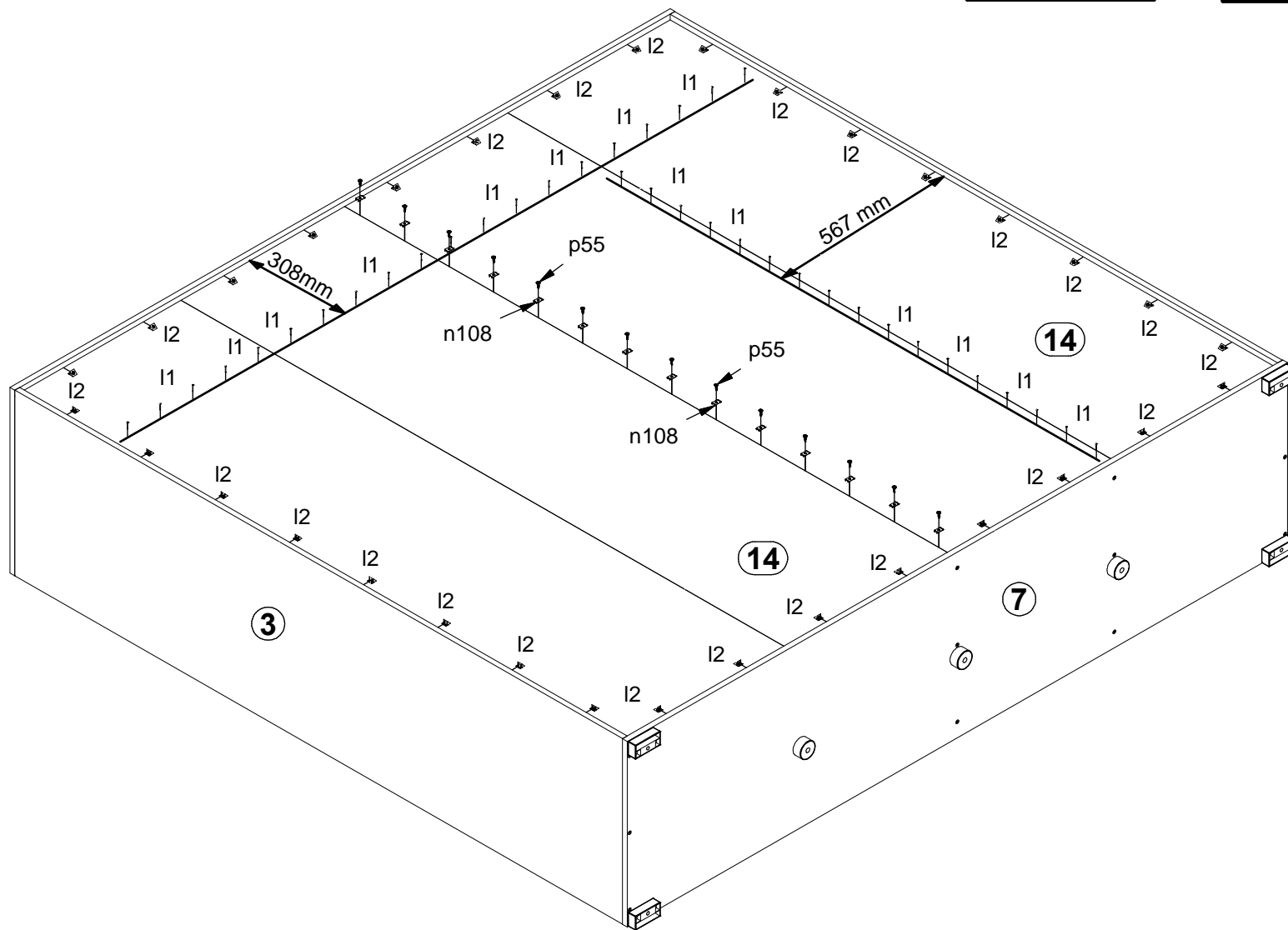
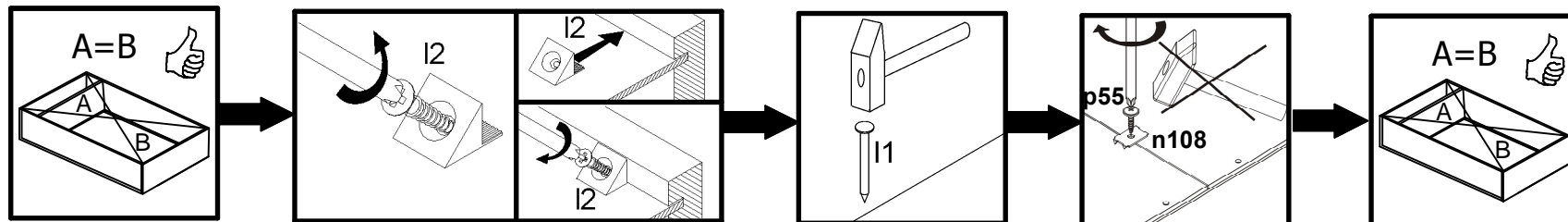

9

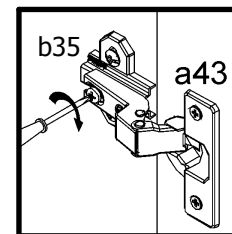
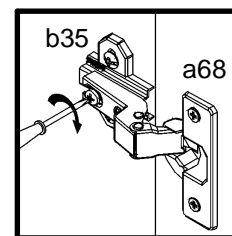
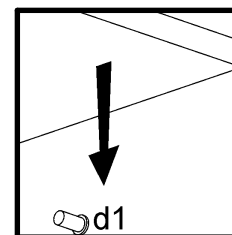
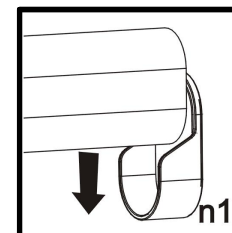
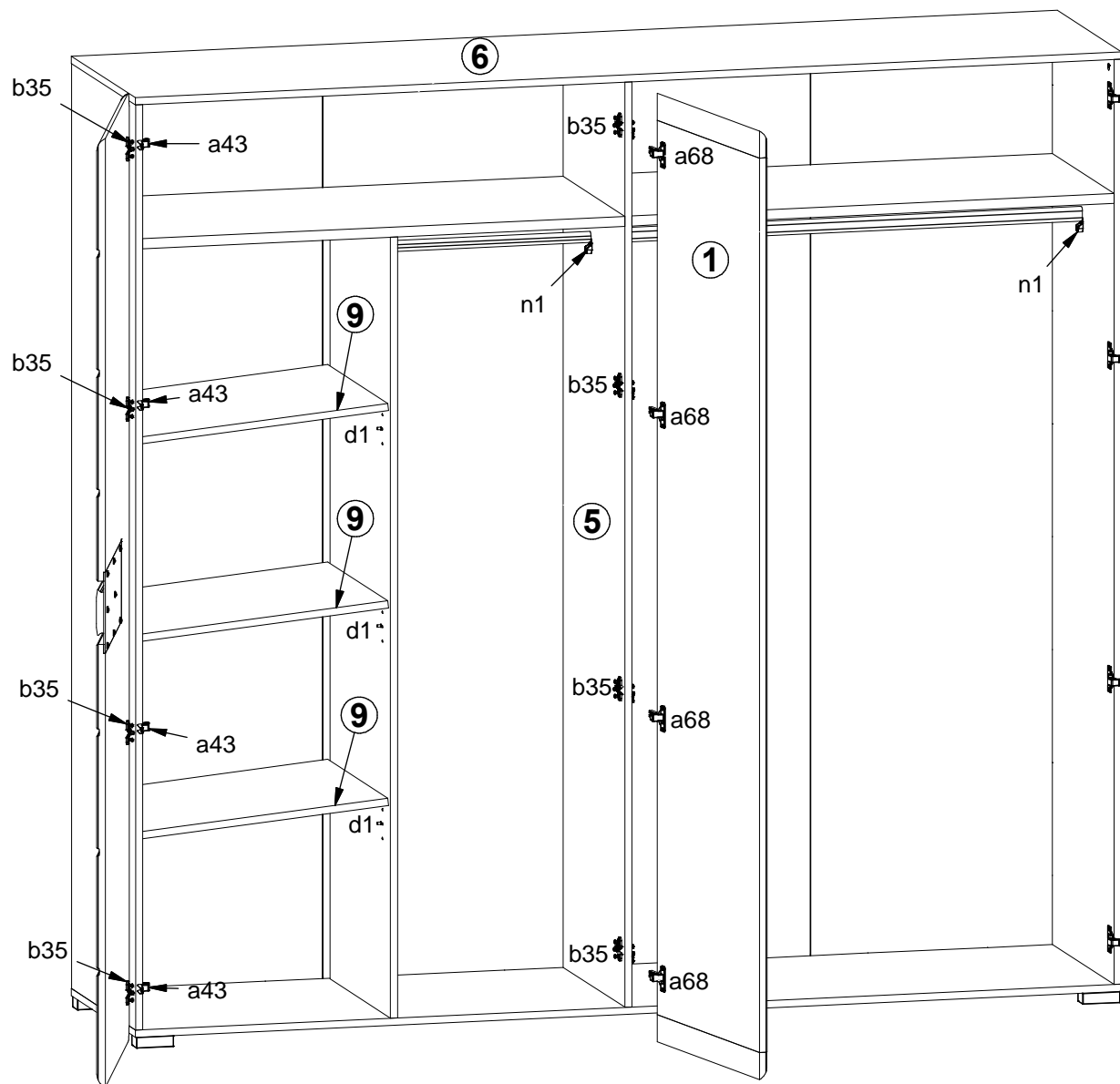

10 §6

