

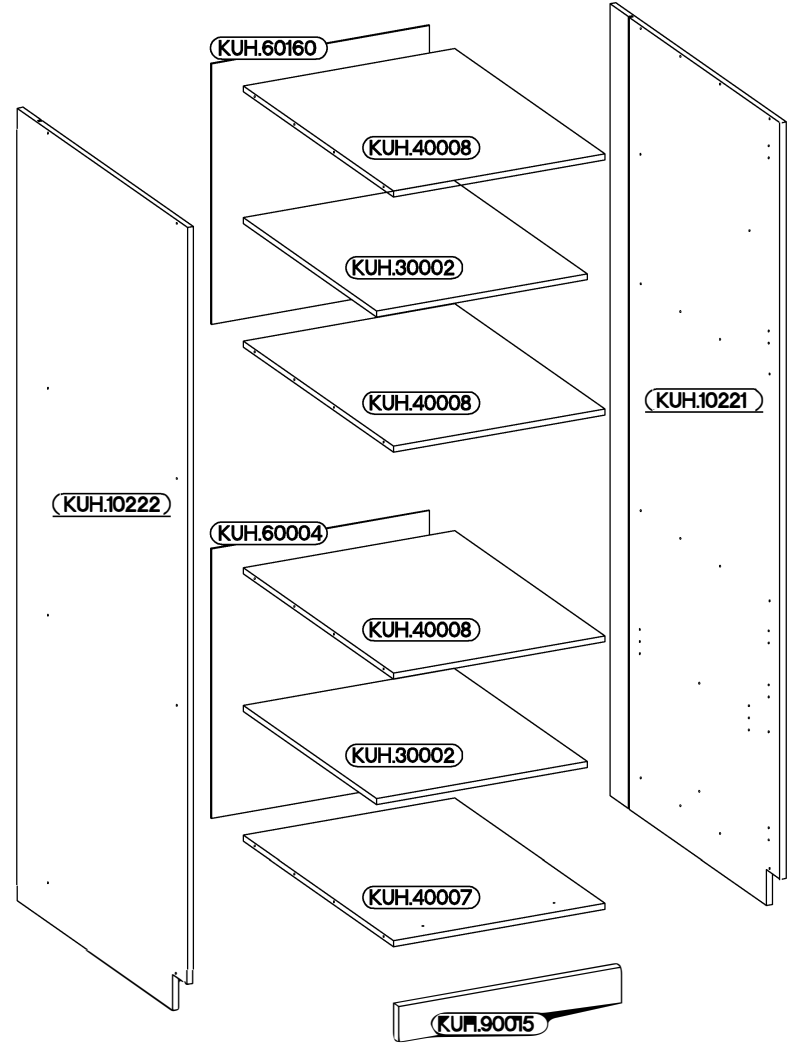

**60 DP-2100 VIRION**

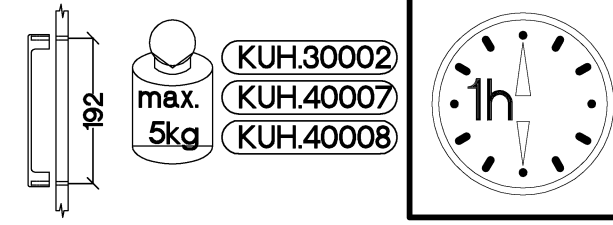

+8x30mm  <b>A</b>	6,4 x 50mm  <b>B</b>	 <b>E1</b>	 <b>E9</b>		
16	16	16	2		
6.5x48x16  <b>F2</b>	+35/0mm  <b>HG</b>	+5/19mm  <b>J</b>	 <b>K28</b>	 <b>K29</b>	 <b>L25</b>
4	4	8	2	1	1
 <b>O</b>	+4.0x45mm  <b>P4</b>	+3.5x13mm  <b>P5</b>	+3.0x20mm  <b>P7</b>	+4.0x30mm  <b>R2</b>	 <b>S15</b>
1	2	14	15-20	4	2

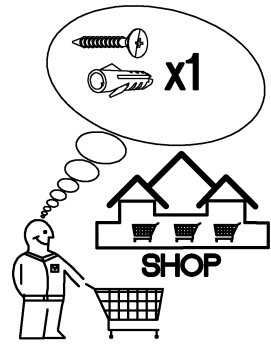
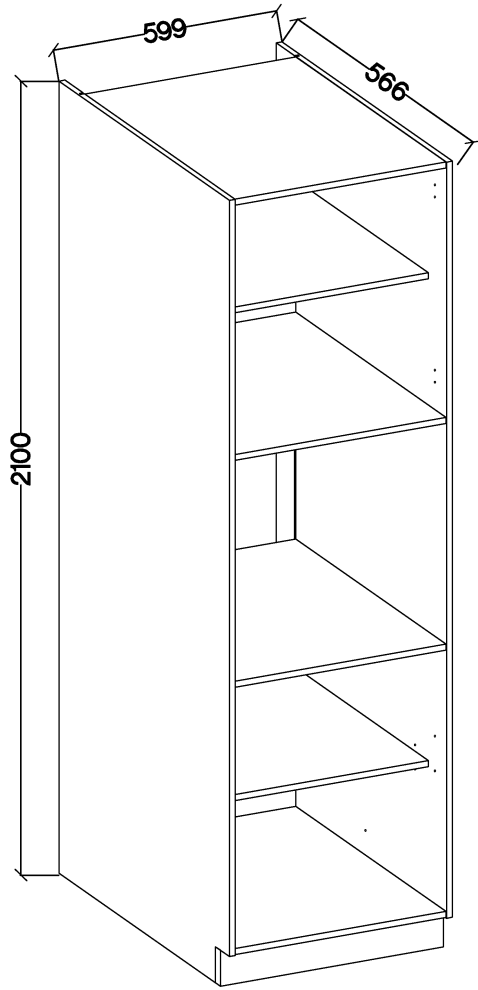
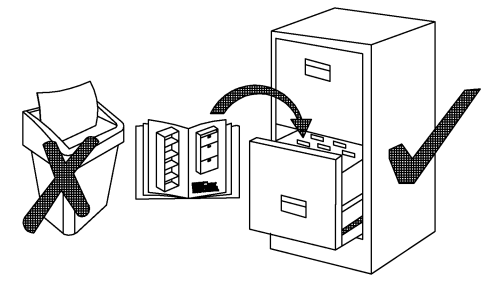

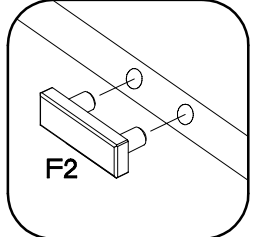
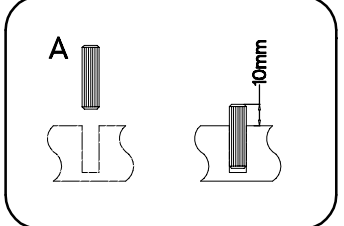
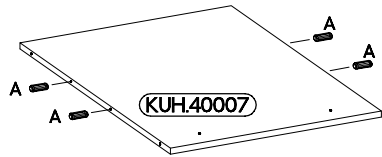
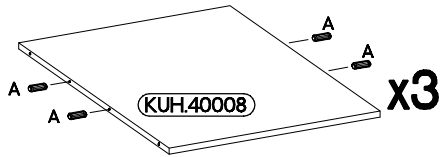
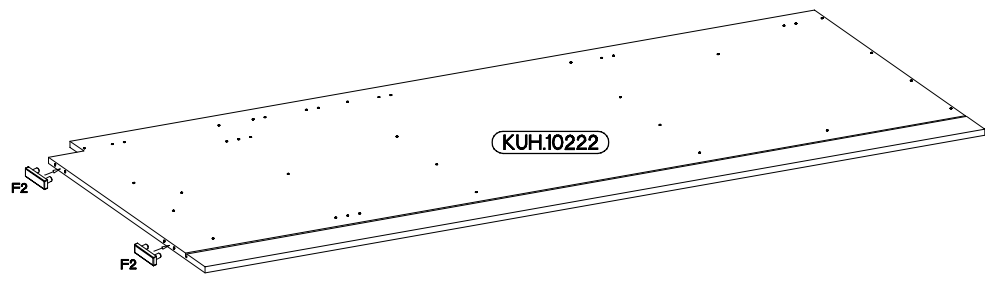
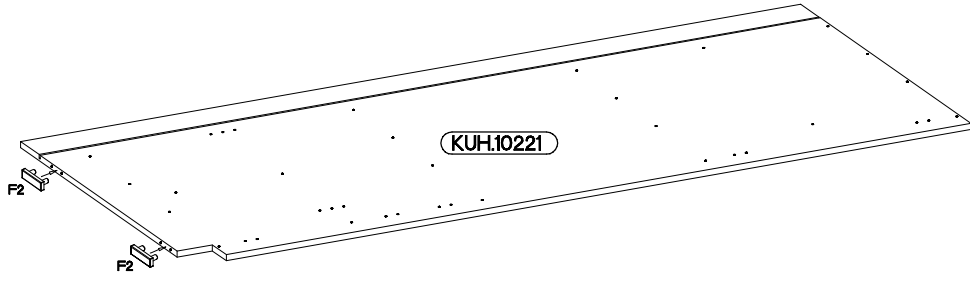
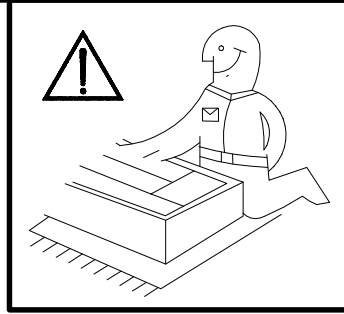

1

6.5x48x16	+8x30mm
	
F2	A
4	16

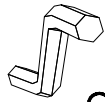

2

6,4 x 50mm		
B	O	E1
8	1	8

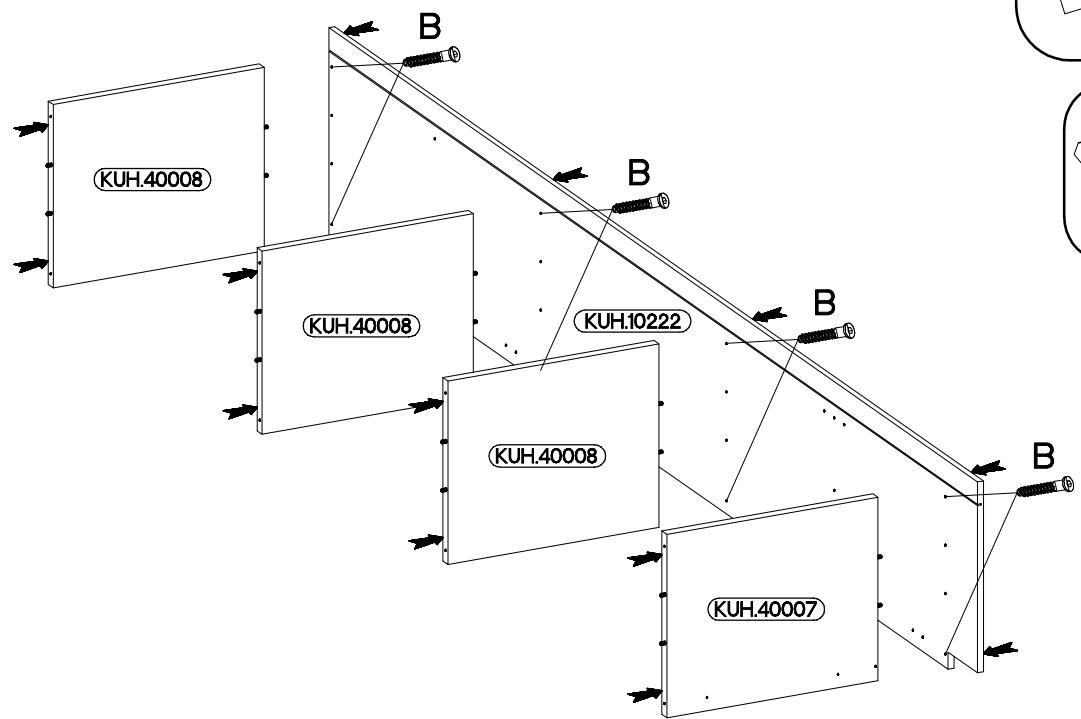
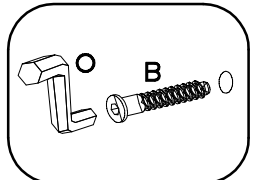
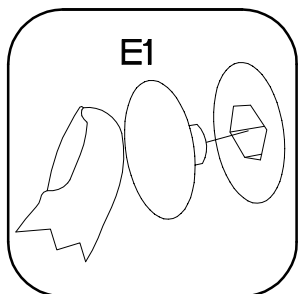

3

6,4 x 50mm

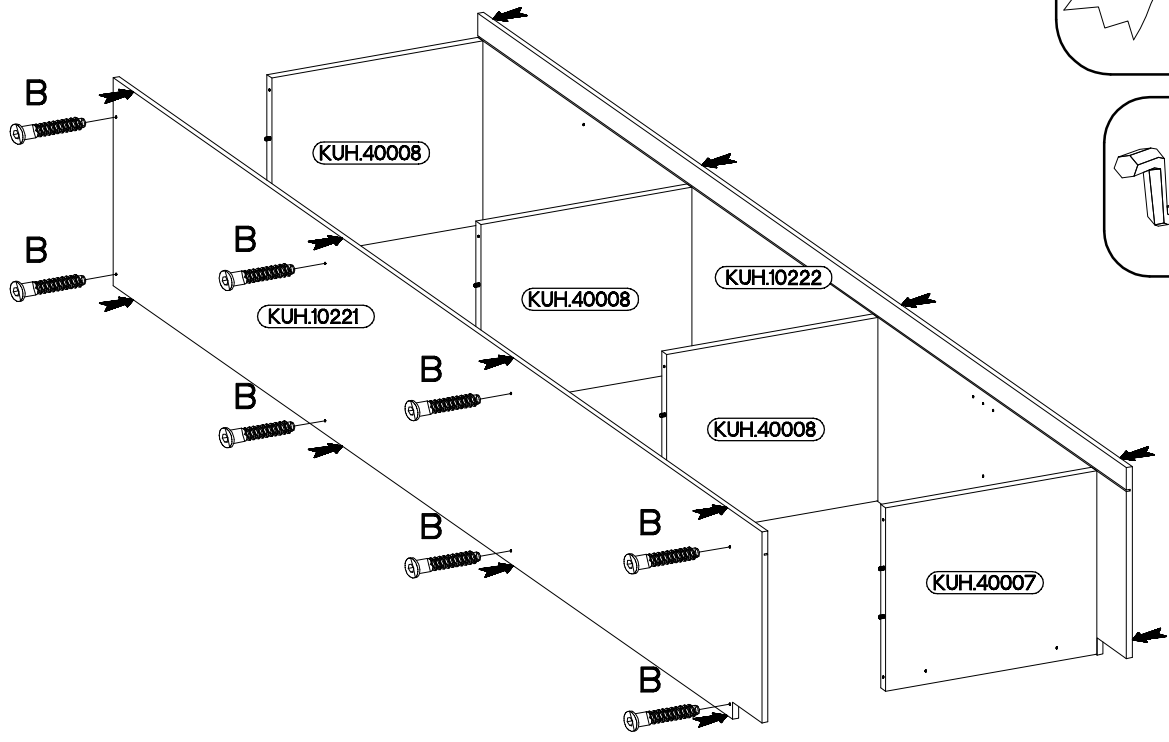
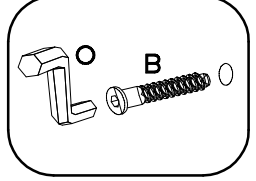
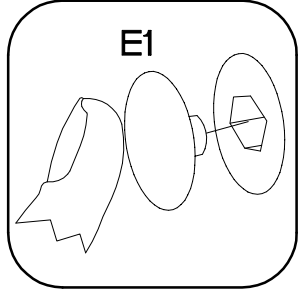
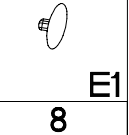
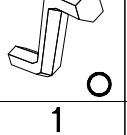
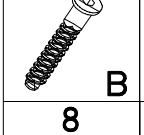

4

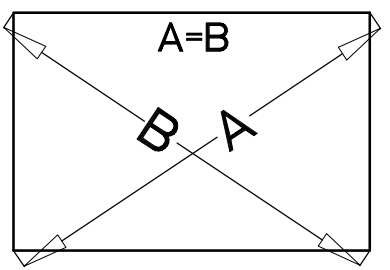
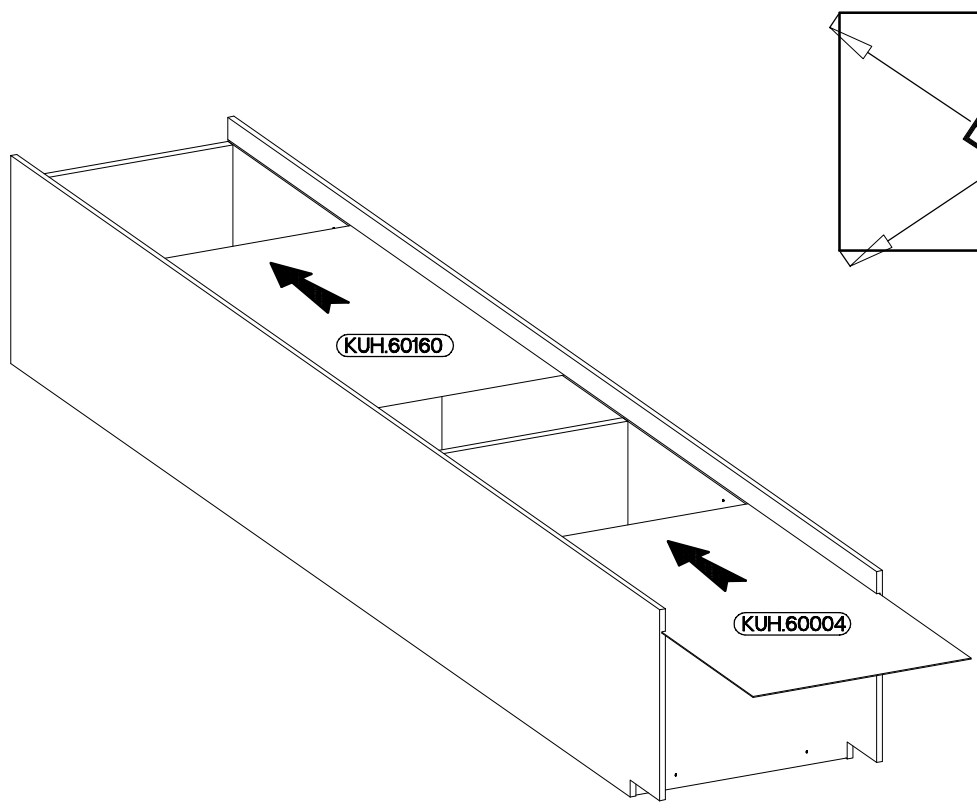

5

±3.0x20mm



P7

15-20

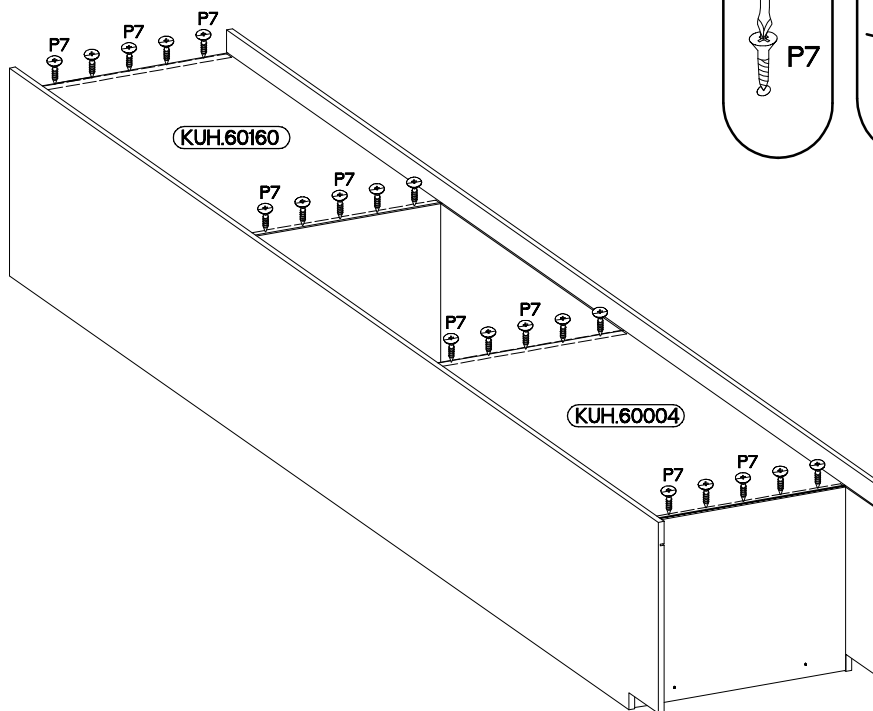
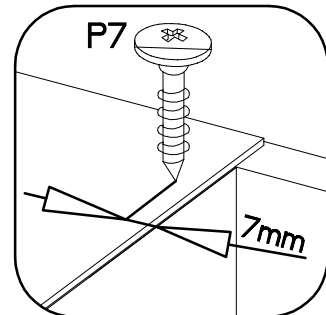
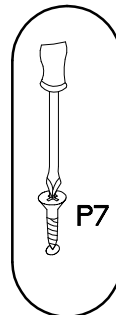

6

±4.0x45mm



P4

2



E9

2

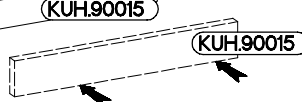
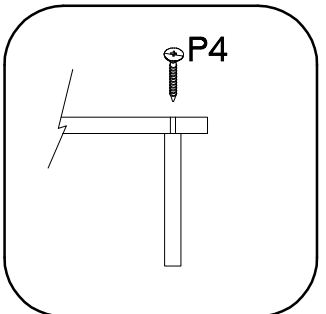
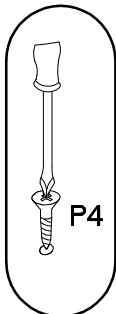
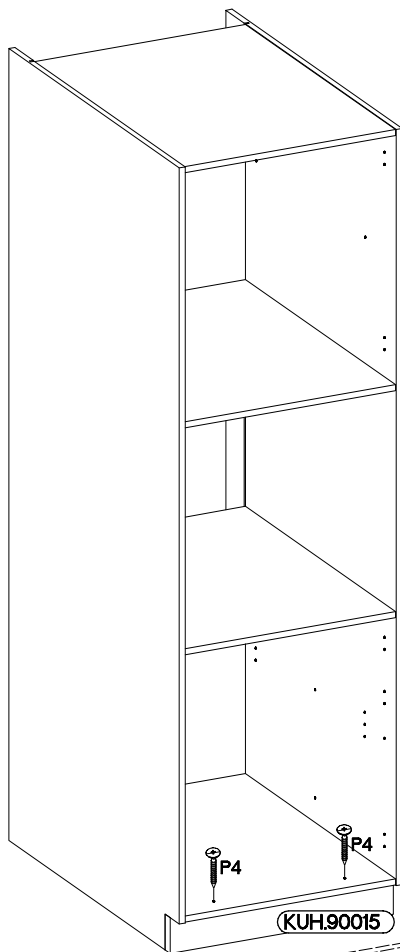

7

±5/19mm

J

8

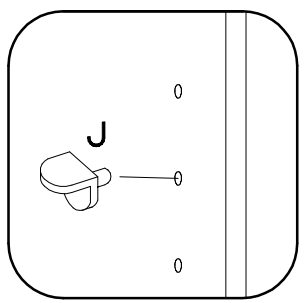
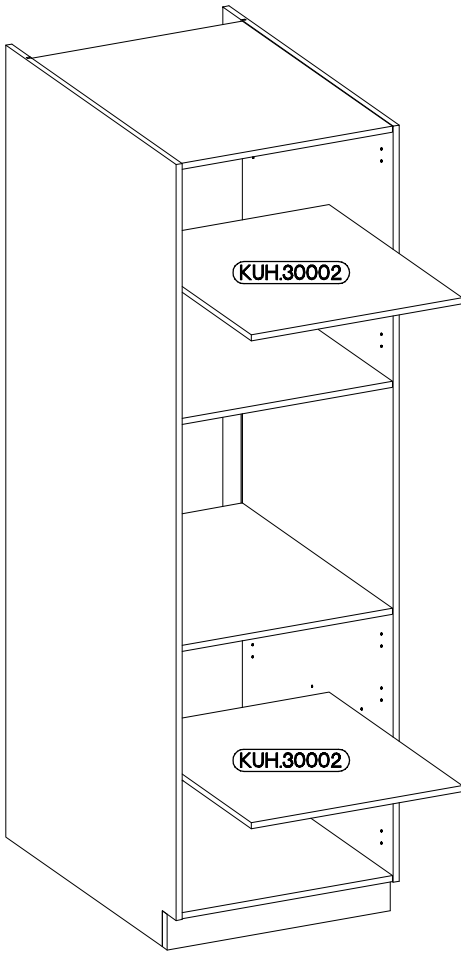

8

±3.5x13mm

L25

1

P5

2

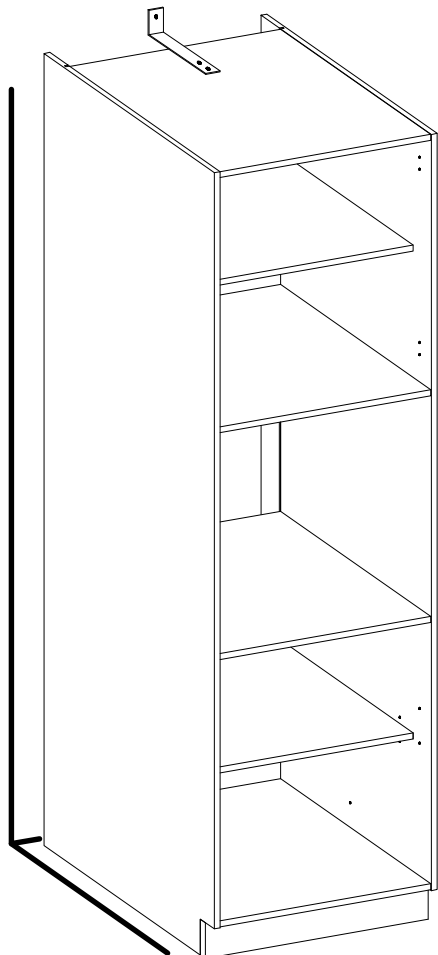

1. L25
2. Ø10mm
- 3.
4. L25
5. L25 P5 P5

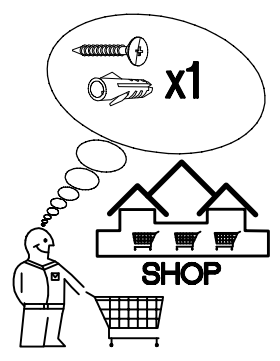
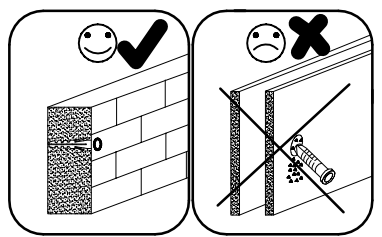

9

60 DP-2100 2F

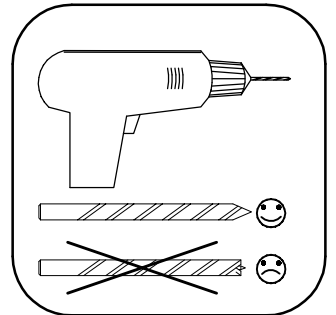
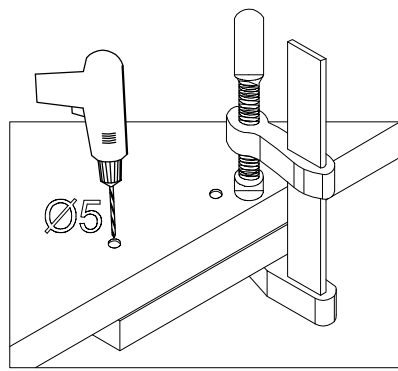
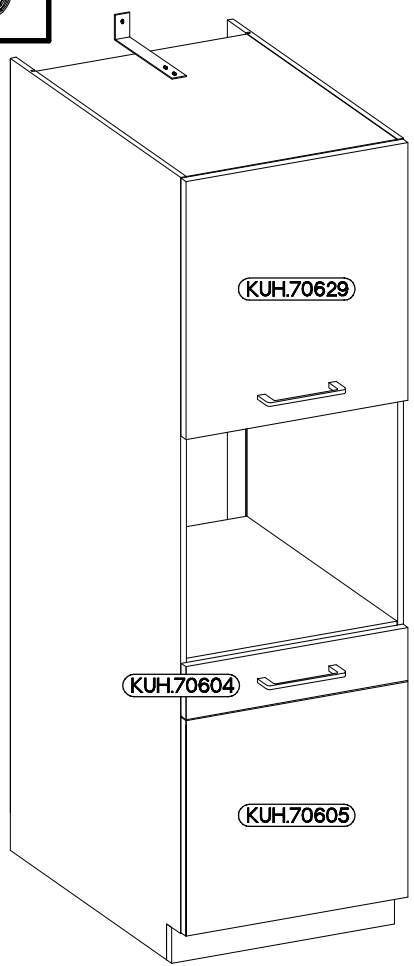

LEFT

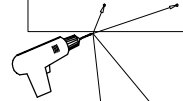
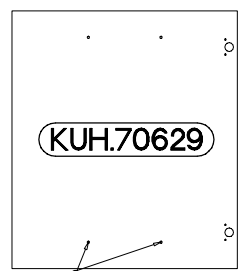
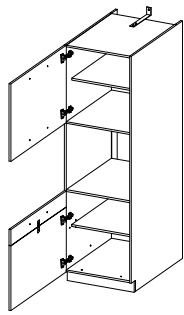

KUH.70604

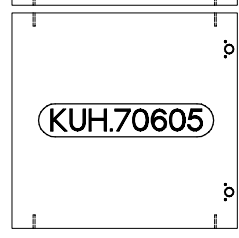
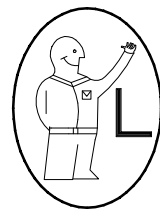

RIGHT

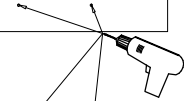
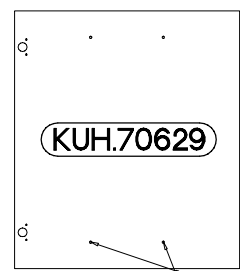
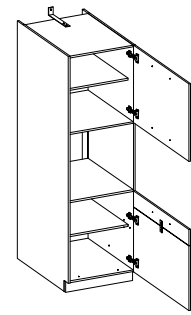

KUH.70604

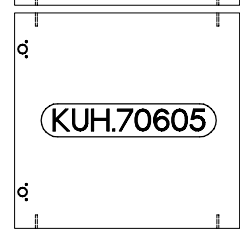

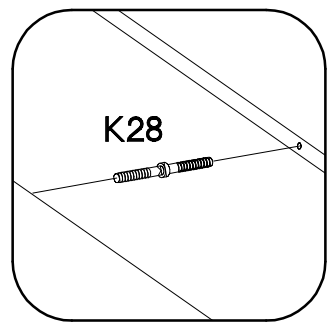
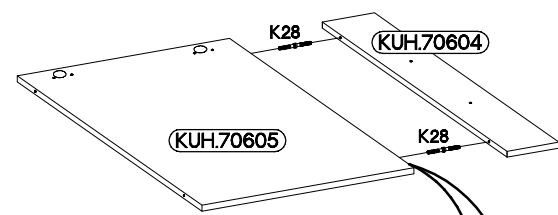
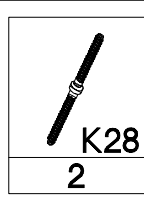

10

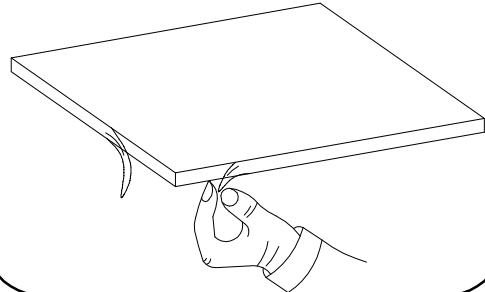

VARIANT HIGH GLOSS



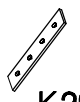

11

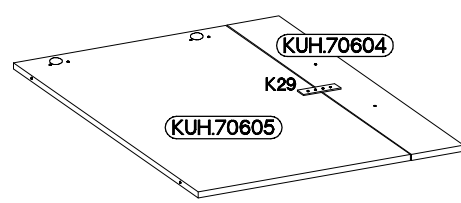
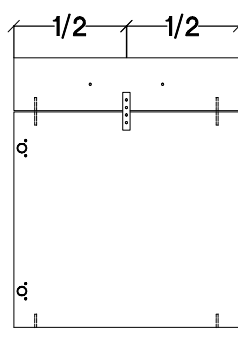
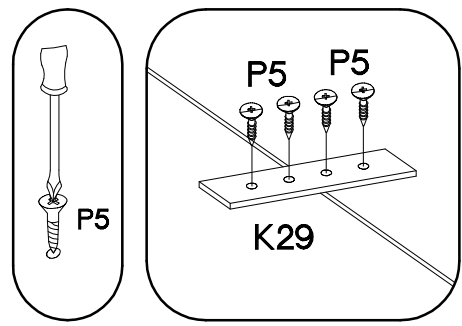
	±3.5x13mm 
K29 1	P5 4

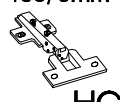

12

±35/0mm 	±3.5x13mm 
HG 4	P5 8

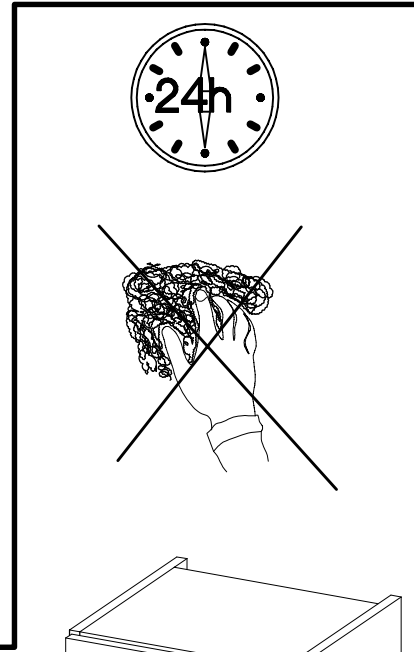
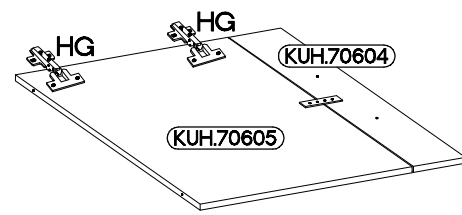
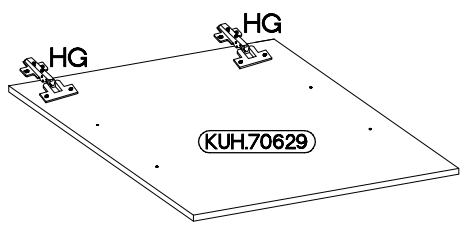
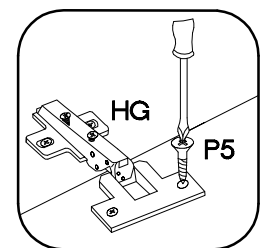
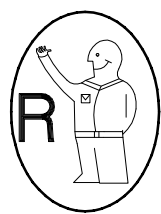

VARIANT HIGH GLOSS

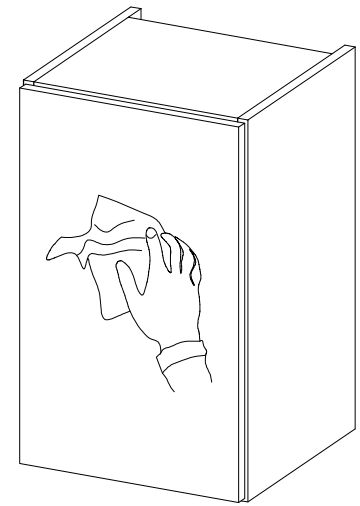
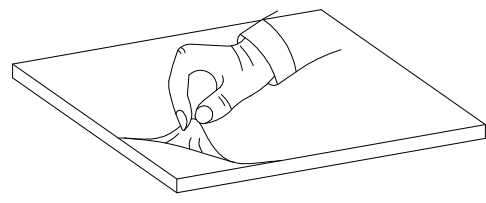
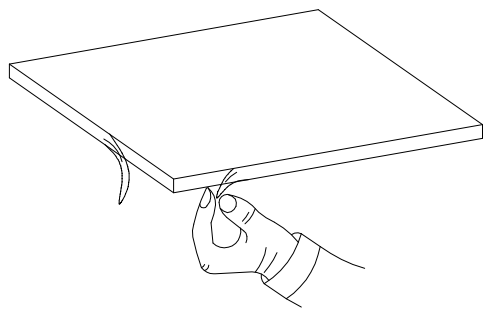

+4.0x30mm



R2

4



S15

2

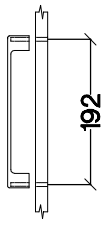

192

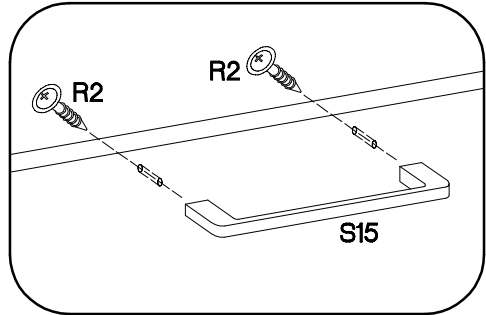

R2

R2

S15

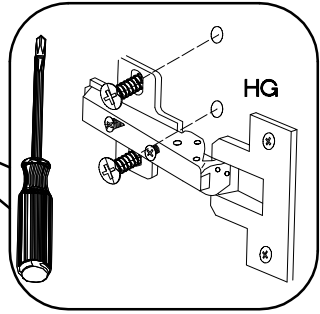
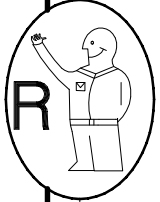

HG

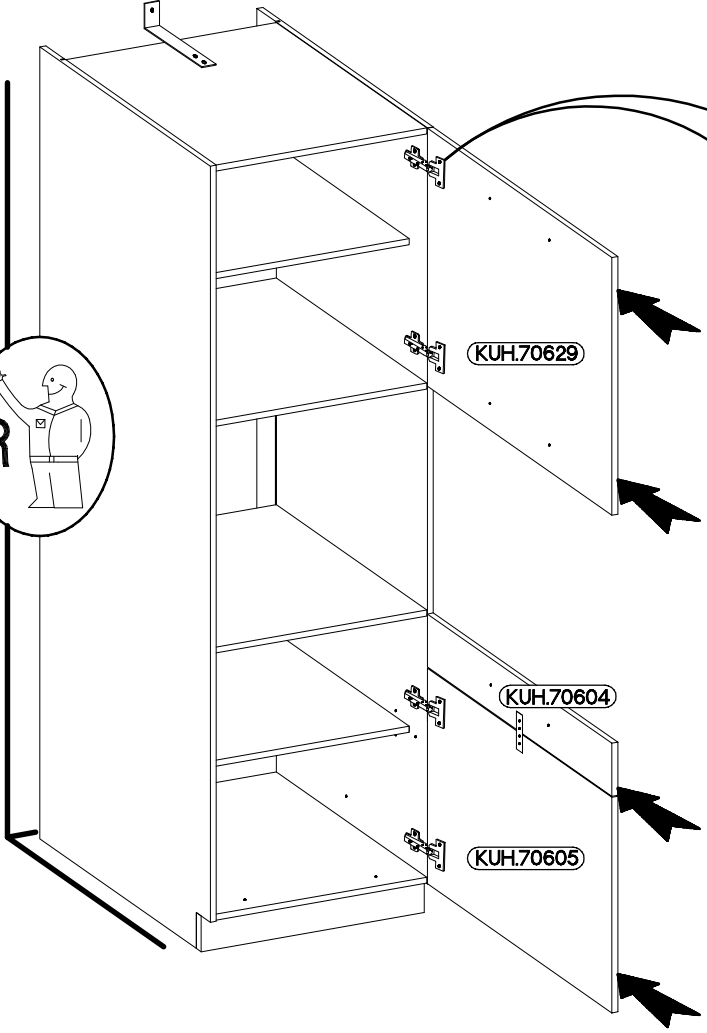

KUH.70629

KUH.70604

KUH.70605

